

N-沟道功率 MOS 管/ N-CHANNEL POWER MOSFET

SIF03N060S

- 特点： 导通电阻低 栅极电荷低，开关速度快 输入阻抗高 符合RoHS规范
- FEATURES: ■LOW $R_{DS(ON)}$ TO MINIMIZE CONDUCTIVE LOSS ■LOW GATE CHARGE FOR FAST SWITCHING
- HIGH INPUT RESISTANCE ■RoHS COMPLIANT
- 应用： 电池供电系统 继电器 开关
- APPLICATION: ■BATTERY OPERATED SYSTEMS ■SOLID-STATE RELAYS
- PRIMARY SWITCH

●最大额定值 (TC=25°C)

●Absolute Maximum Ratings (Tc=25°C) SOT-23

参数 PARAMETER	符号 SYMBOL	额定值 VALUE	单位 UNIT
漏-源电压 Drain-source Voltage	V_{DS}	60	V
栅-源电压 gate-source Voltage	V_{GS}	±20	V
漏极电流 Continuous Drain Current TC=25°C ①	I_D	0.3	A
耗散功率 Total Power Dissipation ①	P_{tot}	0.35	W
最高结温 Junction Temperature	T_j	150	°C
存储温度 Storage Temperature	T_{STG}	-55-150	°C
抗静电击穿 Electronic Static Discharge	ESD	2300	V

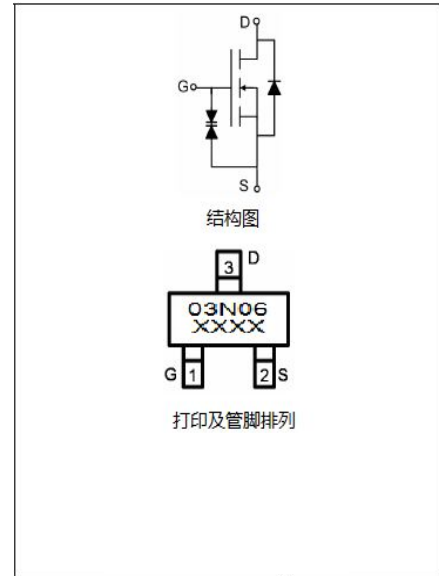

●电特性 (Tc=25°C)

●Electronic Characteristics (Tc=25°C)

参数 PARAMETER	符号 SYMBOL	测试条件 TEST CONDITION	最小值 MIN	典型值 TYP	最大值 MAX	单位 UNIT
漏-源击穿电压 Drain-source Breakdown Voltage	BV_{DSS}	$V_{GS}=0V, I_D=250\mu A$	60	68		V
栅极开启电压 Gate Threshold Voltage	$V_{GS(TH)}$	$V_{GS}=V_{DS}, I_D=250\mu A$	1.0	1.7	2.5	V
漏-源漏电流 Drain-source Leakage Current	I_{DSS}	$V_{DS}=60V, V_{GS}=0V, T_j=25^\circ C$			1	μA
栅极漏电流 Gate-body Leakage Current	I_{GSS}	$V_{GS}=\pm 20V, V_{DS}=0V$		±4	±10	μA
漏-源导通电阻 Static Drain-source On Resistance	$R_{DS(ON)}$	$V_{GS}=10V, I_D=0.5A$ $V_{GS}=5V, I_D=0.4A$		1 1.3	2 3	Ω
跨导 Forwad Transconductance	g_{FS}	$V_{DS}=10V, I_D=0.2A$	0.1			S

●订单信息/ORDERING INFORMATION:

包装形式/PACKING	订货编码/ORDERING CODE	
	普通塑封料/ Normal Package Material	无卤塑封料/Halogen Free
SOT-23 编带装/TAPE & REEL PACKING	SIF03N060S SOT-23-TR	SIF03N060S SOT-23-TR-HF

N-沟道功率 MOS 管/ N-CHANNEL POWER MOSFET

SIF03N060S

参数 PARAMETER	符号 SYMBOL	测试条件 TEST CONDITION	最小值 MIN	典型值 TYP	最大值 MAX	单位 UNIT
输入电容 Input Capacitance	Ciss	$V_{GS} = 0V, V_{DS} = 25V$ $F = 1.0MHz$		21	50	pF
输出电容 Output Capacitance	Coss			11	25	
反向传输电容 Reverse Transfer Capacitance	Crss			4.2	2	
栅极电荷 Total Gate Charge	Qg	$I_D = 0.3A, V_{DS} = 10V$ $V_{GS} = 4.5V$		1.7	3	nC
导通延迟 Turn -On Delay Time	Td(on)	$V_{DD} = 30V, I_D = 0.2A$ $V_{GS} = 10V, R_{GEN} = 10\Omega$		10		ns
开启上升时间 Turn -On Rise Time	T _r			50		ns
关断延迟 Turn -Off Delay Time	Td(off)			17		ns
关断下降时间 Turn -Off Fall Time	T _f			10		ns
二极管正向压降 Diode Forward Voltage	V _{SD}	$T_j = 25^\circ C, I_F = 0.2A$ $V_{GS} = 0V$			1.3	V

●热特性

●Thermal Characteristics

参数 PARAMETER	符号 SYMBOL	最大值 MAX	单位 UNIT
热阻结-壳 Thermal Resistance Junction-case	RthJA	350	°C/W

注释(Notes):

① 以最高结温为限制，T_c=25°C时测试。

I_D & P_D base on maximum allowable junction temperature, test at T_c=25°C.

N-沟道功率 MOS 管/ N-CHANNEL POWER MOSFET

SIF03N060S

● 特性曲线

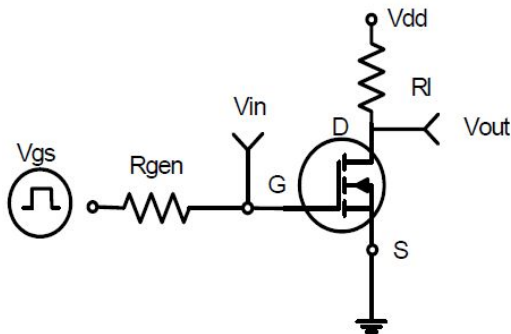

Figure 1: Switching Test Circuit

图 1 开关测试电路

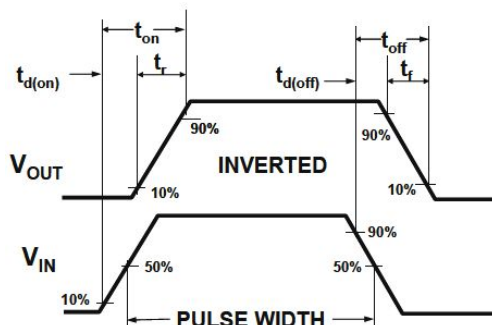

Figure 2: Switching Waveforms

图 2 开关波形

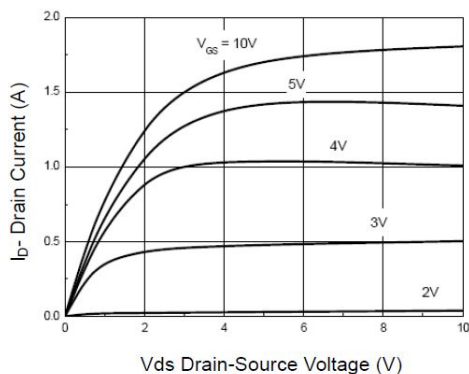

Figure 3 Output Characteristics

图 3 输出特性曲线, Tc=25°C

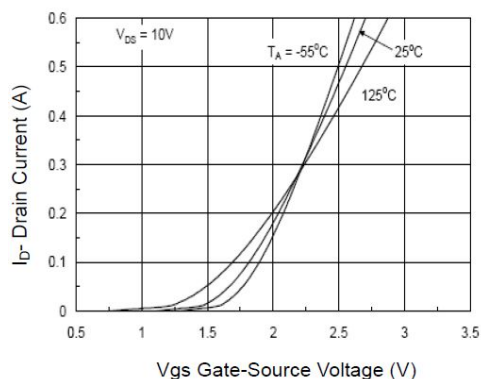

Figure 4 Transfer Characteristics

图 4 转移特性曲线

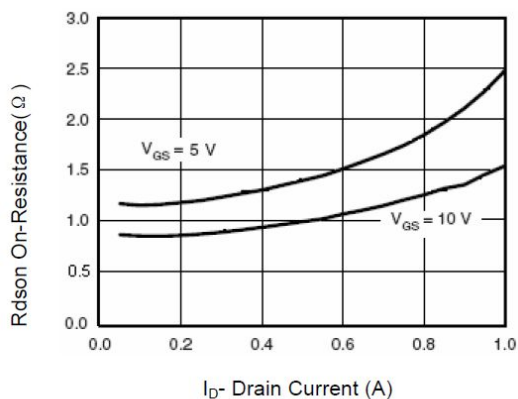

Figure 5 Drain-Source On-Resistance

图 5 导通电阻与漏极电流 曲线

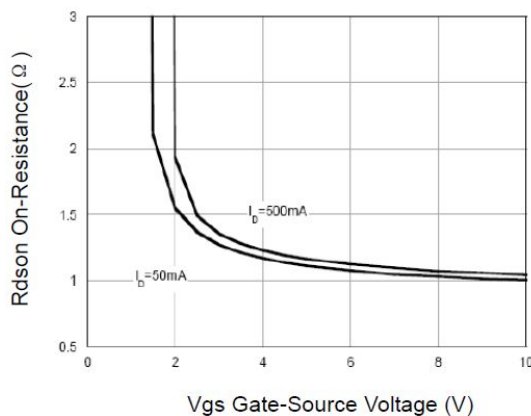

Figure 6 Rds(on) vs Vgs

图 6 导通电阻与栅源电压 曲线

N-沟道功率 MOS 管/ N-CHANNEL POWER MOSFET

SIF03N060S

● 特性曲线

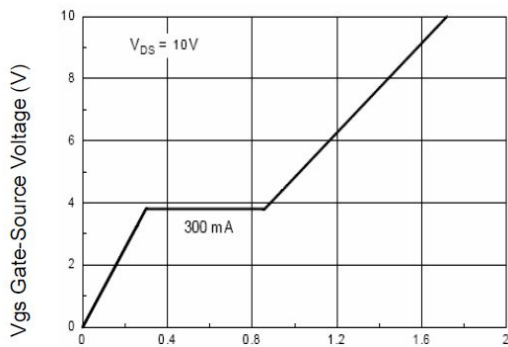

Figure 7 Gate Charge

图 7 栅电荷 曲线

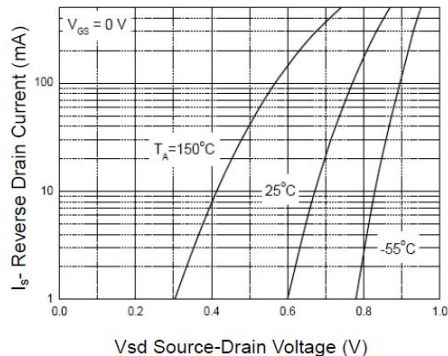

Figure 8 Source-Drain Diode Forward

图 8 反向二极管电流电压 曲线

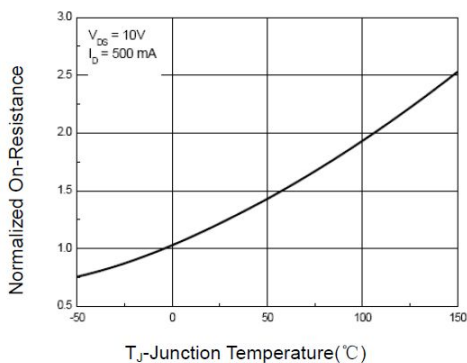

Figure 9 Drain-Source On-Resistance

图 9 导通电阻与结温度 曲线

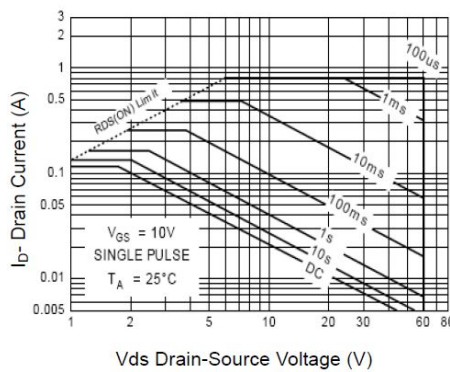

Figure 10 Safe Operation Area

图 10 SOA 曲线图 9 电流-温度曲线

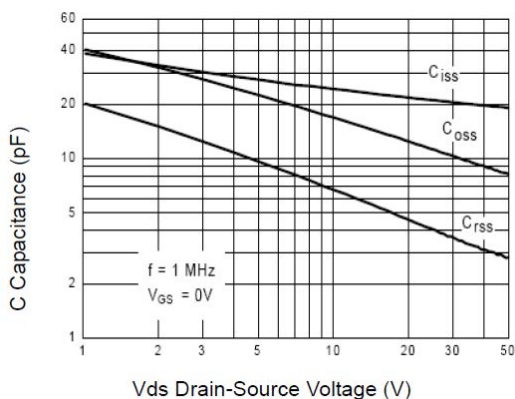

Figure 11 Capacitance vs Vds

图 11 电容特性曲线

N-沟道功率 MOS 管/ N-CHANNEL POWER MOSFET

SIF03N060S

● 特性曲线

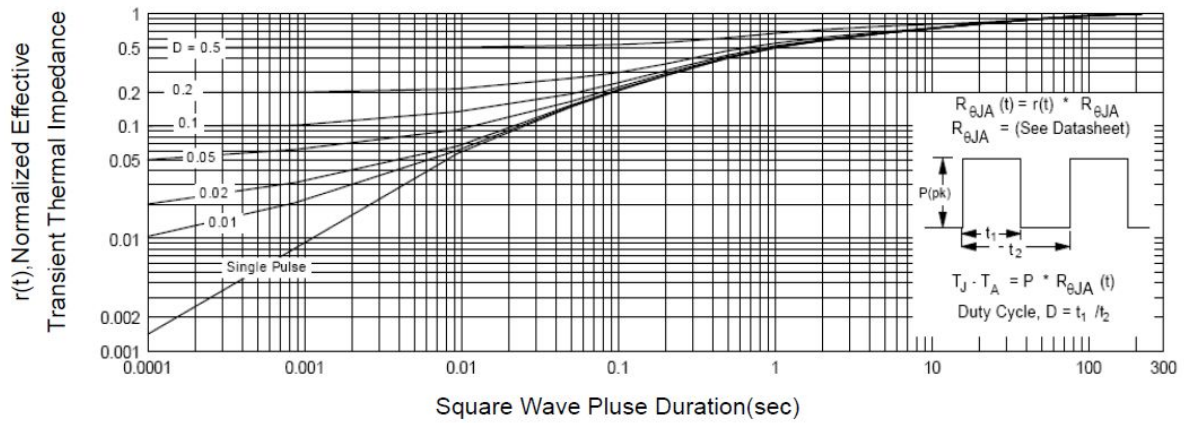

Figure 12 Normalized Maximum Transient Thermal Impedance

图 11 标准化瞬态热阻曲线

SOT-23 封装机械尺寸 SOT-23 MECHANICAL DATA

单位:毫米/UNIT: mm

符号/SYMBOL	最小值/min	典型值/nom	最大值/max
A	2.70		3.10
B	1.15		1.50
C			1.30
D	0.35		0.55
E	2.20		2.70
G	1.70		2.10
H	0.85		1.05
J	0.05		0.20
K	0.00		0.10
L	0.45		0.65
M	0.20		
N	0.90		1.20
P		7°	

lj

